



WPS

AC Servo Nutrunner

Rugged & Versatile
Automatic Tightening Tools



NEW

**Introducing
The GN40S3**

The Smallest Form Factor
in the Industry

New Nutrunner Designs



GN40S1



GN40S3

Compact

60 % size reduction
Tightening in narrow access application

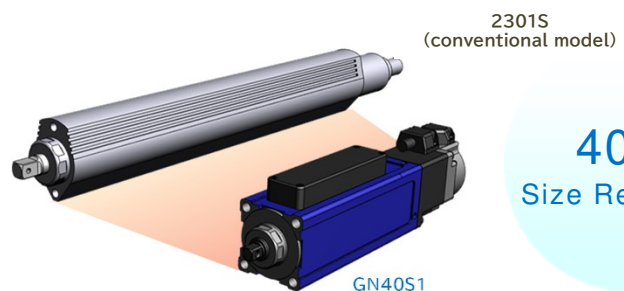

40%
Size Reduction

Lightweight

Approximately 50 % weight reduction,
Reduces the payload on robotic mounted tools

Covers low torque range

M3 size precision screws

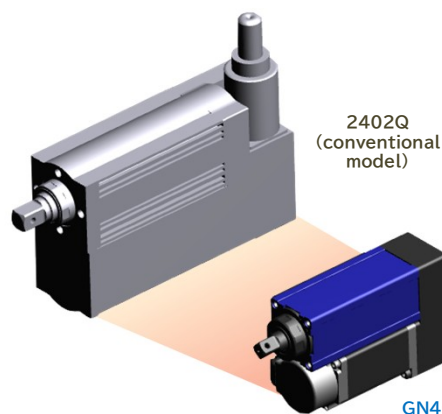

60%
Size Reduction

WPS Controller



WPS-30□-EIP

WPS-75□-EIP

Block	Block Name	Step	Invalid	Loop	Order	Parameters 1	Parameters 2	Jump destination
01	Initial	1			Data Save	Begin		
		2			Load<<	Torque protection	Target Torque	
		3			Mul	Torque protection	1.100	
		4			Torque Lmt	Torque protection		
		5			Timer Reset&Start	Protection Tm		
02	Contact	1			Load<<	Final switching trq	Target Torque	
		2			Mul	Final switching trq	0.500	
		3			Speed Mode	Final tig inlt spd	Stop	
		4		✓	>=Jump	Real Torque	Final switching trq	Next Block
		5	✓	✓	>=Jump	Protection Tm	10.000 sec	Time Out
03	Real Tight	1			Load<<	Peak Torque	0.000 Nm	
		2			Speed Mode	Final tig final spd	Slope	
		3		✓	Trq>=Stop&Jump	Target Torque	Hard	Next Block
		4						
		5						
04	Stop	1		✓	Jump after Stop			Judge
		2						
		3						
		4						
		5						
05	Time Out	1			Speed Mode	0.0 mm/s	Slope	
		2		✓	Jump after Stop			Judge
		3						
		4						
		5						
06	Judge	1			Data Save	End		
		2			Total Judge			
		3						
		4						
		5						
07	End	1			Servo Off			
		2			Program End			
		3						
		4						
		5						

Sample of Program Screen

High-speed program execution

With a high-speed program execution of 0.25 ms per instruction, the WPS system has faster reaction time and better repeatability

Easy-to-understand program

Redesigned programming sequences. The new "block method" makes programming easy to develop both simple and complex processes,. New "labeling" tags allow the programmer to attach names to variables. Automated upgrading of previous generation controller programs to the WPS format.

Batteryless Design

Non-volatile memory design without batteries reduces maintenance over time.

USB memory

Various data and history can be saved. Supports up to 32GB

Tool Lineup

Straight, cube, angle and offset types are available for each model / Torque Range.
Installation on existing equipment is also flexible.



Straight Type

Standard type and multi-axis
Low pitch arrangement type

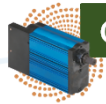

Cube Type

Nutrunner arrangement space compact type



Angle Type

Tightening type for extremely small parts



Offset Type

Smaller pitch tightening type than straight type

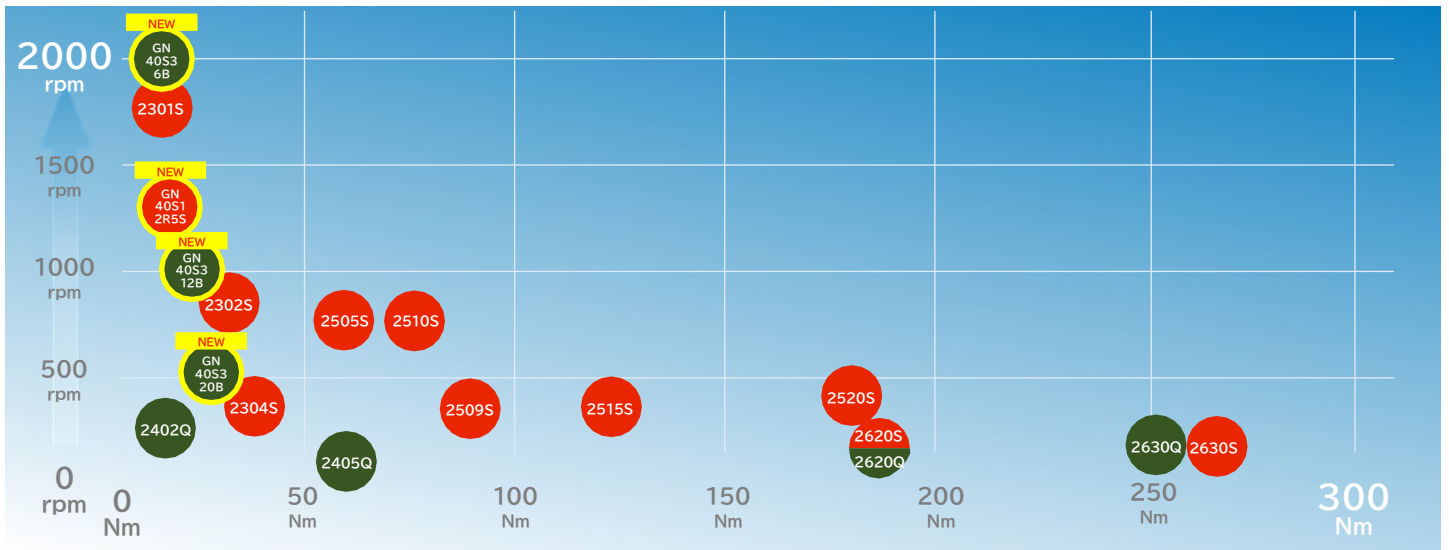

GN series

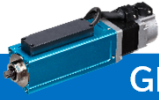

GN40S1 model

Model	Tightening Range	Maximum Number of Revolutions	Weight	Controller Used	Full Length	Width	Shank Width
GN40S1-2R5S	0.25 to 2.5Nm	1,300 rpm	768g (926g including cable)	WPS-NR30 or WPS-NR75	175mm (from mounting part)	40mm x 51mm	□ 6.35

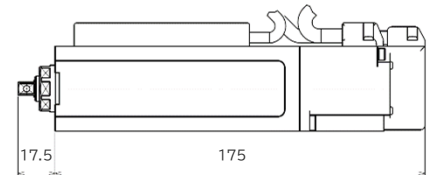
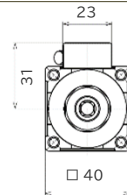

GN40S1



GN40S3 model

Model	Tightening Range	Maximum Number of Revolutions	Weight	Controller Used	Full Length	Width	Shank Width
GN40S3-6B	0.6 to 6Nm	2,000rpm	1,380 g (1480g including cable)	WPS-NR30 or WPS-NR75	118mm (from mounting part)	40 (51) mm × 81mm	□ 9.5
GN40S3-12B	1.2 to 12 Nm	1,000rpm					
GN40S3-20B	2.0 to 20Nm	500rpm					
GN40S3-40B	4.0 to 40Nm	250rpm					

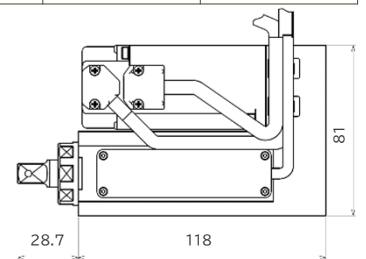
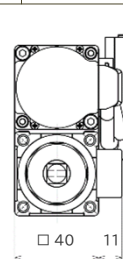

GN40S3

2300S series · 2400Q series

■ Straight type

Model	Tightening Range	Maximum Number of Revolutions	Weight	Specifications Controller
2301S	0.6Nm to 6Nm	1875rpm	1.8kg	WPS-NR30 or WPS-NR75
2302S	2.2Nm to 22Nm	930rpm	1.9kg	
2304S	3.4Nm to 34Nm	440rpm	1.9kg	

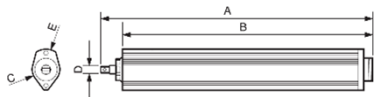

(mm)

A.	B.	φC	□D	φE
367	338	38	9.5	54



Straight type

Straight type
Angle Head

Straight type Offset

■ Cube type

Model	Tightening Range	Maximum Number of Revolutions	Weight	Controller Used
2402Q	1.7Nm to 17Nm	410rpm	3.3kg	WPS-NR30 or WPS-NR75
2405Q	4.7Nm to 47Nm	190rpm	3.3 kg	

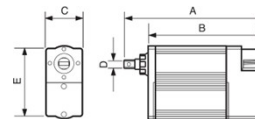

(mm)

A.	B.	φC	□D	φE
215	179	54	12.7	109



cube type

cube type
angle head type

cube type
offset type

2500S series

■ Straight type

Model	Tightening range	Maximum number of revolutions	Weight	Controller used
2505S	5.6Nm to 56Nm	850rpm	5.5kg	WPS-NR75
2509S	9.4Nm to 94Nm	396rpm	5.5kg	
2515S	12Nm~120Nm	396rpm	5.5kg	
2510S	6.8Nm~68Nm	850rpm	5.7kg	
2520S	16.2Nm~162Nm	396rpm	5.7kg	

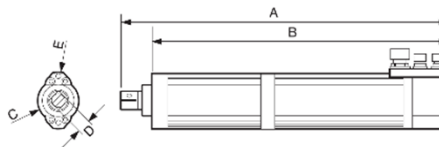

(mm)

Model	A	B	φC	□D	φE
2505S/2509S	430	394	56	12.7	76
2515S	460	417	56	19.05	76
2510S/2520S	518	475	56	19.05	76



Straight type

Straight type Offset

Straight type
Angle Head

There is no cube type in the 2500S series

2600S / 2600Q series

■ Straight type

Model	Tightening range	Maximum number of revolutions	Weight	Controller used
2620S	17.9Nm to 179Nm	240rpm	9.0kg	WPS-NR75
2630S	26.4Nm to 264Nm	170rpm	9.0kg	

A.	B.	φC	□D	φE
445.5	402.5	79	19.05	118.5

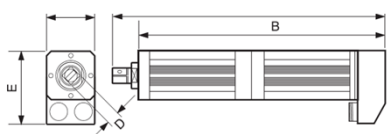

(mm)



straight type

straight type
angle head

straight type
offset

■ Cube type

Model	Tightening range	Maximum number of revolutions	Weight	Controller used
2620Q	18Nm to 180Nm	240rpm	9.5kg	WPS-NR75
2630Q	25.5Nm to 255Nm	170rpm	9.5kg	

A.	B.	φC	□D	φE
287.5	244.5	79	19.05	198.5mm

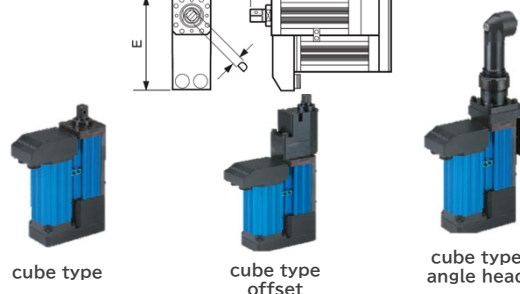
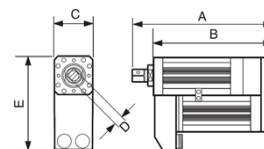

cube type

cube type
offset

cube type
angle head

- Please contact us for higher torque than 264Nm.
- Please contact us for angle head and offset specifications for each series.
- The listed specifications apply when paired to WPS controller. (For CPS Controller Specification, please contact us)

Controller

The new "WPS controller" has arrived, bringing industry leading functionality and data collection!



WPS Controller

Improved torque accuracy and stable yield control

The 0.25 msec. instruction execution time provides high responsiveness and repeatability. A new linearity correction function has been added to achieve superb stability and higher torque accuracy. In addition, new signal processing techniques provides a more consistent yield control, better than ever before.

Expanded product line-up

Significantly improved low torque range. The increased motor capacity and the improved control method, has reduced the volume and weight of the nutrunner, while maintaining the same performance and extending the high-speed rotational range.

Programming Advancements

The innovative programming uses a "block method" providing easy to configure "branches" and "loops". Variables can be assigned, calculated, and compared. The redesign was intended to provide an "easy-to-understand" programming using the new "label method" that allows flexibility, versatility, and flow through. This functionality broadens the application capabilities and possibilities outside of just fastening, to new applications such as Torque / Position Control and functional testing.

Expanded Work Data Storage and Analysis capabilities

Improved data collection and analysis capabilities
Up to 100,000 data points can be saved for each operation waveforms at a sample rate up of up to 4 kHz. Based on torque and angle, up to 4 waveforms can be selected and saved based on tool speed, power supply load factor, torque rate, etc.

USB Memory

Each data and history can be saved

- numeric / waveform data
- program archive
- Alarm record, etc.

Other features

- Firmware update at site



Scope Function

8 types of specific data in the controller can be sent continuously to memory



System Configuration

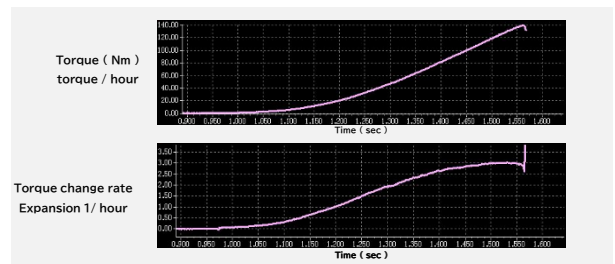
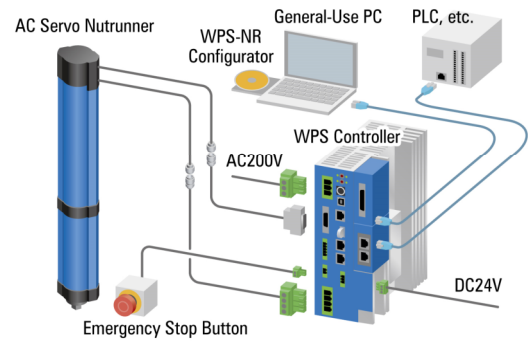

Block	Block name	Step	Invld	Loop	Order	Begin	Parameters 1	Parameters 2	Jump destination
01	Initial	U	U	U	1	Data Load	Angle	Target Torque	
		U	U	U	2	Load+	Torque protection	1.100	
		U	U	U	3	Half	Torque protection		
		U	U	U	4	Torque Limit	Torque protection		
		U	U	U	5	Timer Reset/Start	Final switching trc	0.500	
		U	U	U	6	Load+	Final switching trc	Stop	
02	Contact	U	U	U	1	Speed Mode	Final switching trc	0.500	
		U	U	U	2	Load+	Final switching trc	Stop	
		U	U	U	3	Speed Mode	Final switching trc	0.500	Next Block
		U	U	U	4	Load+	Final switching trc	Stop	
		U	U	U	5	Speed Mode	Final switching trc	0.500	Next Block
		U	U	U	6	Load+	Final switching trc	Stop	
		U	U	U	7	Speed Mode	Final switching trc	0.500	Next Block
		U	U	U	8	Load+	Final switching trc	Stop	
03	Real Tight	U	U	U	1	Speed Mode	Final switching trc	0.500	Next Block
		U	U	U	2	Load+	Final switching trc	Stop	
		U	U	U	3	Speed Mode	Final switching trc	0.500	Next Block
		U	U	U	4	Load+	Final switching trc	Stop	
		U	U	U	5	Speed Mode	Final switching trc	0.500	Next Block
		U	U	U	6	Load+	Final switching trc	Stop	
		U	U	U	7	Speed Mode	Final switching trc	0.500	Next Block
		U	U	U	8	Load+	Final switching trc	Stop	
		U	U	U	9	Speed Mode	Final switching trc	0.500	Next Block
		U	U	U	10	Load+	Final switching trc	Stop	
04	Stop	U	U	U	1	Speed Mode	Final switching trc	0.500	Next Block
		U	U	U	2	Load+	Final switching trc	Stop	
		U	U	U	3	Speed Mode	Final switching trc	0.500	Next Block
		U	U	U	4	Load+	Final switching trc	Stop	
		U	U	U	5	Speed Mode	Final switching trc	0.500	Next Block
		U	U	U	6	Load+	Final switching trc	Stop	
		U	U	U	7	Speed Mode	Final switching trc	0.500	Next Block
		U	U	U	8	Load+	Final switching trc	Stop	
		U	U	U	9	Speed Mode	Final switching trc	0.500	Next Block
		U	U	U	10	Load+	Final switching trc	Stop	
05	Time Out	U	U	U	1	Speed Mode	Final switching trc	0.500	Next Block
		U	U	U	2	Load+	Final switching trc	Stop	
		U	U	U	3	Speed Mode	Final switching trc	0.500	Next Block
		U	U	U	4	Load+	Final switching trc	Stop	
		U	U	U	5	Speed Mode	Final switching trc	0.500	Next Block
		U	U	U	6	Load+	Final switching trc	Stop	
		U	U	U	7	Speed Mode	Final switching trc	0.500	Next Block
		U	U	U	8	Load+	Final switching trc	Stop	
		U	U	U	9	Speed Mode	Final switching trc	0.500	Next Block
		U	U	U	10	Load+	Final switching trc	Stop	
06	Judge	U	U	U	1	Speed Mode	Final switching trc	0.500	Next Block
		U	U	U	2	Load+	Final switching trc	Stop	
		U	U	U	3	Speed Mode	Final switching trc	0.500	Next Block
		U	U	U	4	Load+	Final switching trc	Stop	
		U	U	U	5	Speed Mode	Final switching trc	0.500	Next Block
		U	U	U	6	Load+	Final switching trc	Stop	
		U	U	U	7	Speed Mode	Final switching trc	0.500	Next Block
		U	U	U	8	Load+	Final switching trc	Stop	
		U	U	U	9	Speed Mode	Final switching trc	0.500	Next Block
		U	U	U	10	Load+	Final switching trc	Stop	
07	End	U	U	U	1	Speed Mode	Final switching trc	0.500	Next Block
		U	U	U	2	Load+	Final switching trc	Stop	
		U	U	U	3	Speed Mode	Final switching trc	0.500	Next Block
		U	U	U	4	Load+	Final switching trc	Stop	
		U	U	U	5	Speed Mode	Final switching trc	0.500	Next Block
		U	U	U	6	Load+	Final switching trc	Stop	
		U	U	U	7	Speed Mode	Final switching trc	0.500	Next Block
		U	U	U	8	Load+	Final switching trc	Stop	
		U	U	U	9	Speed Mode	Final switching trc	0.500	Next Block
		U	U	U	10	Load+	Final switching trc	Stop	

Controller model notation

Indicates the hardware version

WPS-NR30*-***-***
-NR75*-***-***

Code indicating the optional circuit board of option slot 1

Code indicating the optional circuit board of option slot 2

Optional Circuit Board

Field bus	CCL
	DEV
Industrial-use Ethernet	PFN
	EIP
	CIF
P/I/O	NPN
	PNP
Dedicated Ethernet circuit board	SET
Analog monitor	ANM

Controllers specifications

Model	WPS-NR30	WPS-NR75
control power supply	DC24V±10 %	
power supply	3 to 200-230V±10 % 50/60Hz	
cooling method	natural air cooling	Built-in fan forced air cooling
Regeneration function	-	80W regenerative resistance
External size (mm)	60×180×242	75×190×242
Compatible models (series)	GN40S1 / GN40S3 / 2300 / 2400	Compatible with all models

What's New in

Waveform Synchronous Trace

This is a new debugging function that allows the user to synchronize and operate execution blocks on the program and cursors on the waveform graph.

This makes it easier to develop the program contents, analyze waveforms and improve process control.

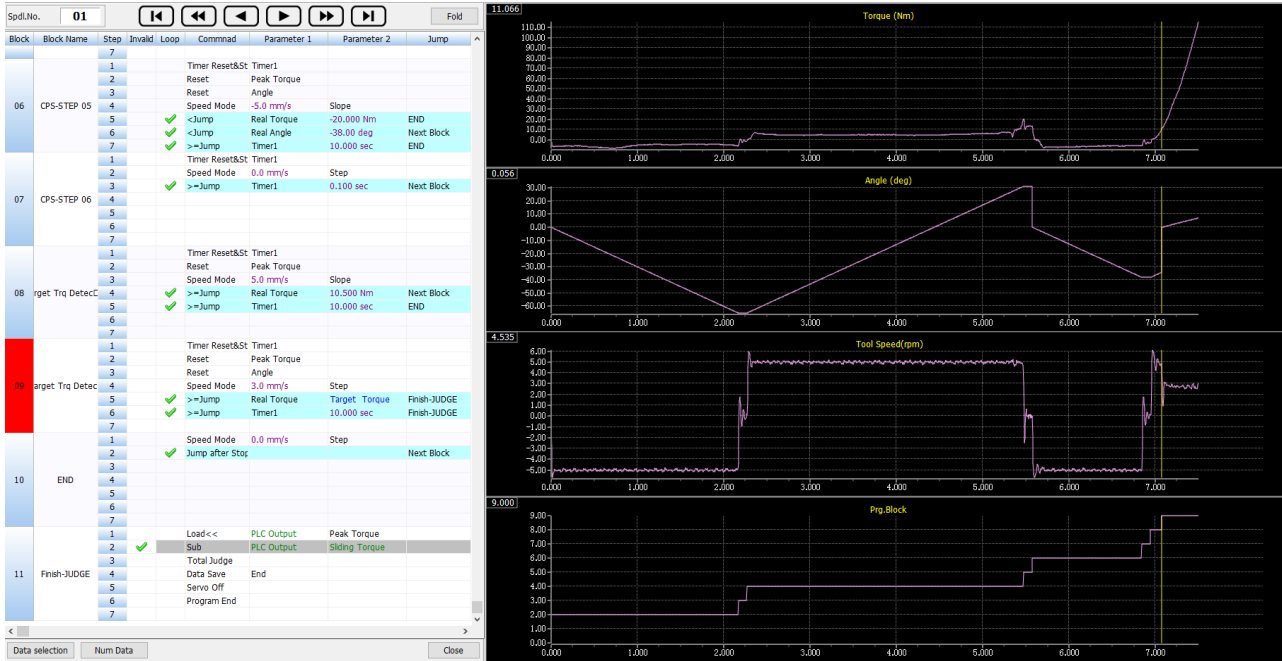

WPS Widelink

This feature is intended for supervisory control of the WPS controller from the PLC as well as for expanded data communication. Versatile network communications are available for the number of devices.

The intent is to improve ease of use, simplify the programming complexity, and reduce overall costs.

Recipe function

This is a new program operation setting method for easily handling large numbers of product types with the same process structure.

255 parameters such as operation target values and judgment values that are commonly used, can be set and executed, eliminating the need to create a large number of near identical programs.

This significantly reduces programming time and makes it possible to omit the conventional ladder that rewrites the program table. Fastener Tightening according to the target product type is possible by simply specifying the recipe number.

The concept of the recipe function

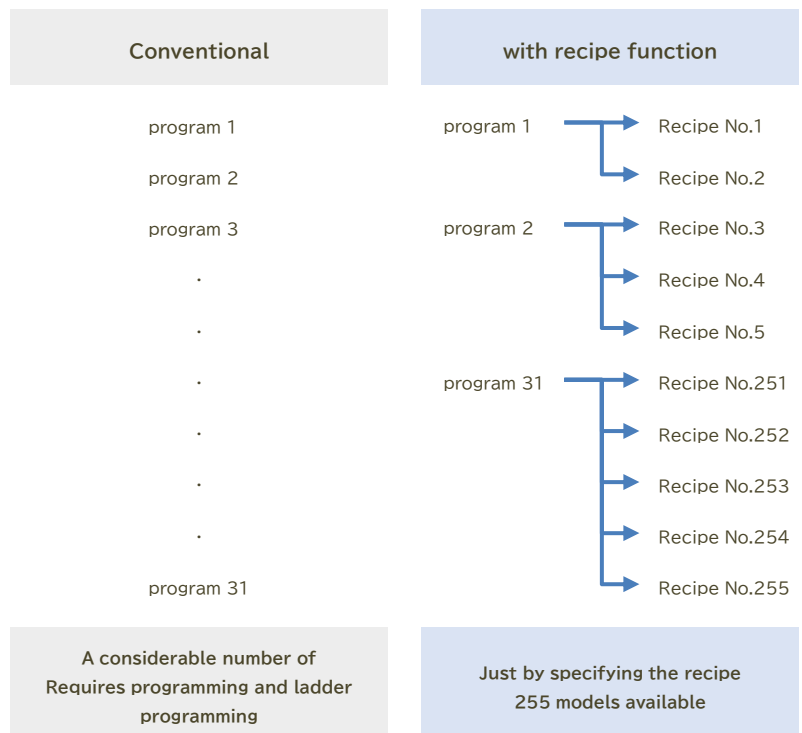



Dedicated option

Slide Joint

Features

The slide joint is the tip attachment of the AC servo nutrunner. We offer a wide variety of slide joints, quick joints and socket adapters in various sizes.

Please check the catalog for the lineup and applicable models of the AC servo nutrunner.



CORETEC INC.

Head office/Factory 500 Akahama, Soja-shi, Okayama 719-1121, JAPAN
TEL +81 866- 94-9016 FAX +81 866-94-1178

Chubu office 2-14 Akebono-cho, Toyota-shi, Aichi 471-0835, JAPAN
TEL +81 565-71-9000 FAX +81 565-71-9010

Kanto office Fuji Building 3rd floor, 2-7-4 Shinyokohama, Kohoku-ku, Yokohama-shi, Kanagawa, 222-0033, JAPAN
TEL +81 45-442-9088 FAX +81 45-442-9089

CORETEC is the brand logo of CORETEC's NB brand.



acquati group

a burster Italia product division

EUROPEAN REPRESENTATIVE

Via Repubblica, 10- 24035 Curno BG

Tel.: +39/035/618120 @: info@acquatigroup.com

URL <https://www.coretec.co.jp> E-mail info@coretec.co.jp

Specifications subject to change without notice.

CTG-0002